

PURE



Owner's manual EN

Bedienungsanleitung DE

Manuel de l'utilisateur FR

Manuale dell'utente IT

Brugsvejledning DK

Gebruikershandleiding NL

one
elite

The radio for everyone

⚠ Safety instructions

Keep the radio away from heat sources.
Do not use the radio near water.
Avoid objects or liquids getting into the radio.
Do not remove screws from or open the radio casing.
Fit the mains adaptor to an easily accessible socket, located near the radio and ONLY use the mains power adapter supplied. Always switch the unit off and disconnect it from mains power before inserting or removing a ChargePAK.

⚠ Sicherheitshinweise

Halten Sie das Radio fern von Heizquellen.
Benutzen Sie das Radio nicht in der Nähe von Wasser.
Verhindern Sie, dass Gegenstände oder Flüssigkeiten in das Radio gelangen.
Entfernen Sie keine Schrauben vom Gehäuse und öffnen Sie dieses nicht.
Schließen Sie das Netzteil an eine leicht erreichbare Steckdose in der Nähe des Radios an, und benutzen Sie AUSSCHLIESSLICH das mitgelieferte Netzteil.
Schalten Sie das Gerät immer aus und trennen Sie es vom Netz, bevor Sie ein ChargePAK einsetzen oder entnehmen.

⚠ Consignes de sécurité

Tenir la radio éloignée de toute source de chaleur.
Ne pas utiliser la radio à proximité d'un point d'eau.
Éviter que des objets ou des liquides ne pénètrent à l'intérieur de la radio.
Ne pas ouvrir le boîtier de la radio ou en enlever les vis.
Branchez l'adaptateur sur une prise de courant facilement accessible, à proximité de la radio et utilisez UNIQUEMENT l'adaptateur fourni. Toujours éteindre la radio et la débrancher du secteur avant d'insérer ou de retirer le ChargePAK.

⚠ Istruzioni di sicurezza

Tenere la radio lontana da fonti di calore.
Non utilizzare la radio vicino all'acqua.
Evitare che oggetti o liquidi penetrino nella radio.
Non rimuovere le viti né aprire l'involucro della radio.
Collegare l'adattatore di rete ad una presa della corrente facilmente accessibile, situata vicino alla radio e utilizzare ESCLUSIVAMENTE l'adattatore di rete fornito. Prima di inserire o rimuovere un ChargePAK, è indispensabile spegnere l'unità e scollegarla dalla rete di alimentazione.

⚠ Sikkerhedsforskrifter

Hold radioen på afstand af varmekilder.
Brug ikke radioen i nærheden af vand.
Undgå at der kommer genstande eller væske i radioen.
Fjern ikke skruer fra og åbn ikke radiokabinettet.
De bør tilslutte strømforsyningen til et lettilgængeligt strømudtag tæt på radioen. De bør KUN bruge den medfølgende strømforsyning. Sluk altid for enheden, og afbryd den fra hovedstrømforsyningen, før du isætter eller fjerner ChargePAK.

⚠ Veiligheidsinstructies

Houd de radio uit de buurt van warmtebronnen.
Gebruik de radio niet in de buurt van water.
Vermijd dat voorwerpen of vloeistoffen in de radio terechtkomen.
Verwijder geen schroeven uit de omkasting van de radio en open het niet.
Steek de lichtnetadapter in een gemakkelijk toegankelijk stopcontact in de buurt van de radio en gebruik ALLEEN de meegeleverde spanningsadapter voor het lichtnet. Voordat u een ChargePAK invoert of verwijdert, moet u altijd eerst de unit uitzetten en de stekker uit het stopcontact halen.

Warranty information

Imagination Technologies Ltd. warrants to the end user that this product will be free from defects in materials and workmanship in the course of normal use for a period of two years from the date of purchase. This guarantee covers breakdowns due to manufacturing or design faults; it does not apply in cases such as accidental damage, however caused, wear and tear, negligence, adjustment, modification or repair not authorised by us. Please visit www.pure.com/register to register your product with us. Should you have a problem with your unit please contact your supplier or contact PURE Support at the address shown on the rear of this manual. If you need to return your product please use the original packaging and include all parts and accessories. We reserve the right to refuse incomplete or badly packaged returns.

Garantie-Informationen

Imagination Technologies Ltd. garantiert dem Endbenutzer, dass dieses Produkt für die Dauer von zwei Jahren ab Kaufdatum bei normalem Gebrauch frei von Schäden an Material oder Verarbeitung ist. Diese Garantie umfasst Ausfälle aufgrund von Herstellungs- und Konstruktionsfehlern; sie gilt nicht für Unfallschäden, wie auch immer verursacht, Verschleiß, Fahrlässigkeit und Veränderung oder Reparatur durch von uns nicht autorisierte Personen. Registrieren Sie Ihr Produkt bei uns unter www.pure.com/register. Sollten Sie mit Ihrem Gerät ein Problem haben, wenden Sie sich an Ihren Verkäufer oder den PURE Support. Die Adresse finden Sie auf der Rückseite dieser Bedienungsanleitung. Verwenden Sie bei Rücksendungen bitte die Originalverpackung und fügen Sie alle Teile und das vollständige Zubehör bei. Wir behalten uns das Recht vor, unvollständige oder unzureichend verpackte Rücksendungen abzulehnen.

Garantie

Imagination Technologies Ltd. garantit à l'utilisateur que le présent produit est exempt de défauts en termes de matériaux et de main-d'œuvre, dans le cadre d'une utilisation normale, pour une période de deux ans à compter de la date d'achat. La présente garantie couvre les pannes dues à un défaut de conception ou de fabrication; elle ne prend pas en compte les dommages accidentels, quelle que soit leur cause, l'usure normale du produit, ainsi que tous dommages dus à la négligence, à la modification, au réglage ou à la réparation effectuée(e) sur l'appareil sans notre autorisation. Visiter le site www.pure.com/register pour enregistrer votre produit auprès de nos services. En cas de problème avec votre appareil, veuillez contacter votre fournisseur ou le centre d'assistance PURE, à l'adresse indiquée au dos du présent manuel. Si vous souhaitez retourner votre article, veuillez le renvoyer dans son emballage d'origine et ne pas oublier de retourner également tous les éléments/accessoires du produit. Nous nous réservons le droit de refuser tout article retourné qui serait incomplet ou mal emballé.

Informazioni sulla garanzia

Imagination Technologies Ltd. garantisce all'utente finale che il presente prodotto è esente da difetti di materiale e fabbricazione in condizioni normali di utilizzo per un periodo di due anni a partire dalla data di acquisto. La presente garanzia copre i danni dovuti a difetti di fabbricazione o progettazione; non si applica in casi quali danni accidentali, in qualsiasi modo siano stati provocati, usura, negligenza, regolazione, modifica o riparazione non autorizzate. Visitare il sito www.pure.com/register per registrare il prodotto. In caso di problemi relativi all'unità, contattare il proprio fornitore oppure contattare il Supporto tecnico PURE all'indirizzo indicato sul retro del presente manuale. Nel caso in cui il prodotto debba essere restituito, è necessario utilizzare l'imballaggio originale, includendo tutte le parti e gli accessori. Ci riserviamo il diritto di respingere prodotti restituiti con l'imballaggio incompleto o danneggiato.

Garantioplysninger

Imagination Technologies Ltd. garanterer over for slutbrugeren, at dette produkt ikke er fejlbehæftet, hvad angår materialer og håndværksmæssig udførelse ved normal brug i to år fra købsdatoen. Denne garanti dækker sammenbrud, der skyldes fremstillings- eller designfejl. Den dækker ikke i tilfælde, hvor enheden beskadiges som følge af hændigt uheld, uanset hvordan dette sker, samt slitage, uagtsomhed, justering, ændring eller reparation, som ikke er godkendt af os. Besøge www.pure.com/register for at registrere produktet hos os. Hvis der skulle opstå problemer med enheden, bedes du kontakte leverandøren eller PURE Support på adressen, der er angivet på bagsiden af denne vejledning. Hvis det bliver nødvendigt at returnere dit produkt, skal du bruge den originale emballage og vedlægge alle komponenter og tilbehørsdele. Vi forbeholder os ret til at afvise ufuldstændige eller dårligt emballerede produkter.

Informatie over de waarborg

Imagination Technologies Ltd. waarborgt de eindgebruiker dat dit product vrij is van defecten in materialen en werkuren bij normaal gebruik voor een duur van twee jaar vanaf de datum van aankoop. Deze garantie dekt defecten door productie- of ontwerpfouten; het is niet van toepassing in gevallen als accidentele schade, hoe ook veroorzaakt, slijtage, onachtzaamheid, instelling, wijziging of reparatie die door ons niet werd goedgekeurd. Bezoek www.pure.com om uw product bij ons te registreren. Indien u een probleem hebt met uw apparaat, gelieve uw leverancier te contacteren of contacteer PURE Support op het adres op de achterzijde van deze handleiding. Als u uw product moet retourneren, gebruikt u de oorspronkelijke verpakking en voegt u alle onderdelen en accessoires bij. Wij behouden het recht om onvolledige of slecht verpakte retourzendingen te weigeren.

Contents

Getting started	2
Setting up	2
Controls at a glance.....	3
Connectors.....	3
Connecting an iPod or MP3 player	3
Listening to radio	4
Adjusting the volume	4
Switching between DAB and FM	4
Changing stations.....	4
Using Presets	5
Changing the information displayed on screen	5
Using textSCAN™ to pause and control scrolling text	5
Intellitext®	6
ReVu™ – pause and rewind live radio	6
Setting the alarm & timers	7
Setting the alarm.....	7
Setting the kitchen timer.....	8
Setting the sleep timer.....	8
Options and settings	9
DAB options	9
Autotune.....	9
Intellitext options	9
FM options.....	9
General options.....	9
Backlight.....	9
Audio	9
Clock.....	9
Energy saving.....	10
Software upgrade	10
Using a ChargePAK™	10
Help and specifications	11
Secondary and inactive stations	11
Hints and tips.....	11
Technical Specifications	12

Getting started

Setting up

Note: If you have a ChargePAK C6L rechargeable battery (sold separately) fit the battery BEFORE plugging the radio in. Follow the fitting instructions supplied with the ChargePAK C6L.

- 1
 - a) Lift the aerial from the clip on the top of the radio and fully extend it **A**.
 - b) Insert the connector of the supplied mains adapter into the socket on the rear of the radio **B**.
 - c) Plug the mains adapter into the mains supply **C** and wait for the radio to switch on.

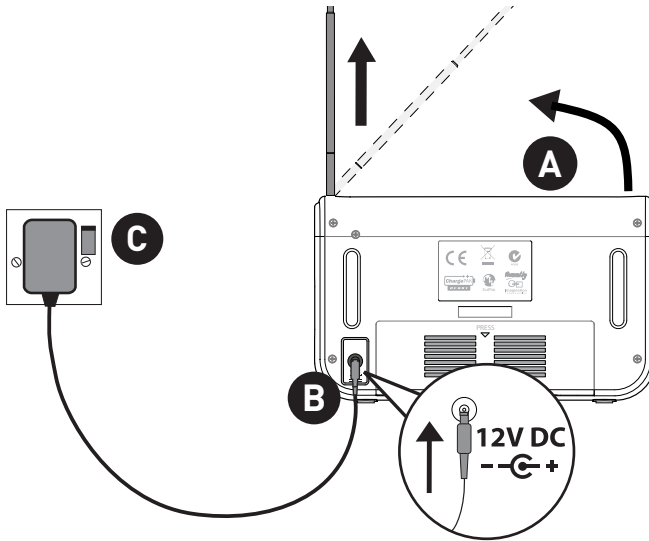

- 2 Wait for ONE Elite to complete an Autotune, which finds all available DAB stations (this takes about a minute). When the Autotune is complete, a station will be selected.

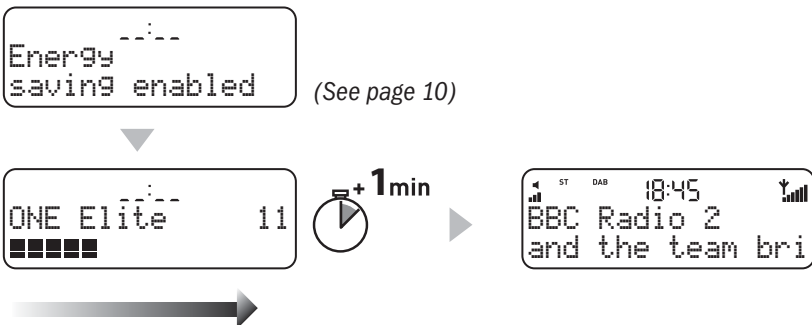

Controls at a glance

Volume

Press to display volume level then rotate dial to adjust.

Stations

Press to display station list. Rotate dial to browse stations; press dial to select.

Presets

Store up to 50 DAB or FM preset stations.

Alarm/Timer

Set the alarm, kitchen timer or sleep timer.

ReVu

Press to pause and play live radio then rotate dial to fast-forward/rewind. Press and hold to return to live radio.

Standby

Switch on and into standby or off if ChargePAK/ batteries fitted.

Info

Press to change the on-screen information.

DAB/FM

Switch between DAB and FM.

Intellitext

View news, sports results and more from participating stations.

Menu

Display setup options.

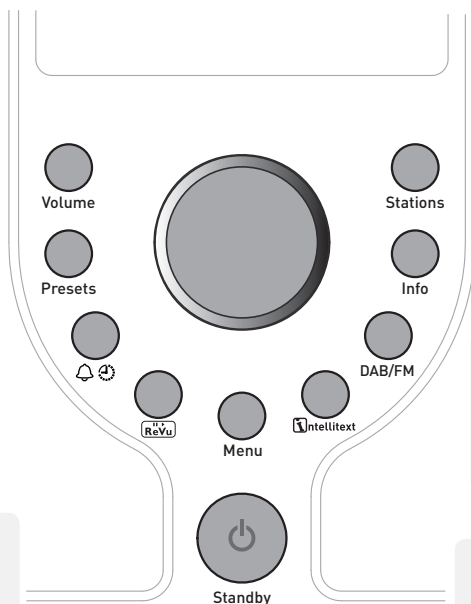

Centre dial

As well as changing the station and adjusting the volume the dial is also used for other functions like textSCAN and fast-forward and rewind, which are explained in the relevant sections of this manual.

Connectors



USB connector for software upgrades (mini-B type).

Analogue stereo input for iPod, MiniDisc, etc.

3.5mm headphone socket.

Connecting an iPod or MP3 player

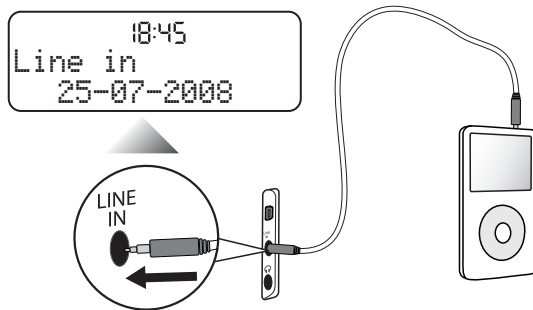

(AUX cable not supplied)

Listening to radio

Adjusting the volume

(From menus and ReVu®)



Switching between DAB and FM

Press the DAB/FM button.

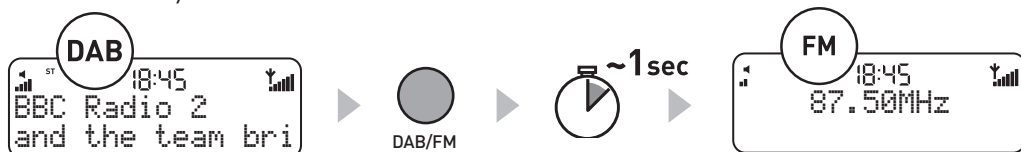

Changing stations

When listening to DAB

1. Press the **Stations** button to display the station list on the bottom line of the display.
2. Turn the dial right or left to scroll through the list of available DAB stations. The name of the current station remains at the top of the screen.
3. Push the dial to change the station.



When listening to FM

Seek Tuning

Press the **Stations** button and rotate the dial right or left to seek to the next or previous FM station that has a strong signal.



Manual Tuning

1. Change the FM tuning mode to 'Manual' (see page 9).
2. Press the **Stations** button then rotate the dial right or left to step up or down 0.05 MHz.

Using Presets

You can store up to 25 DAB and 25 FM presets.

Storing a Preset

1. Tune to the DAB or FM station you want to store as a preset.
2. Press the **Presets** button to open the presets list.
3. Rotate the dial to scroll to a preset slot between 1 and 25.
4. **Push and hold** the dial until the 'Preset saved' message appears on screen.

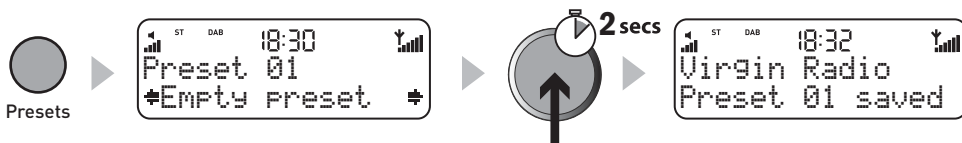

Selecting a Preset

1. Press the **Presets** button to open the presets list.
2. Rotate the dial to browse your list of preset stations.
3. Press the dial to tune to a preset station.

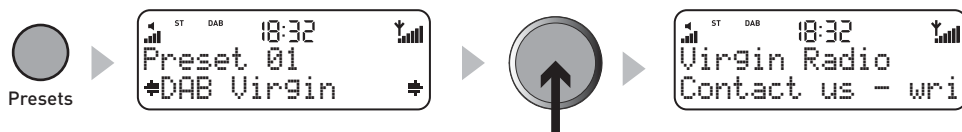

Changing the information displayed on screen

Press the **Info** button to switch between the following information:

- | | |
|-----------------------|--|
| Scrolling text | Information broadcast by most DAB stations and some FM (RDS) stations. |
| Date | Today's date automatically updated by the DAB signal. |

Using textSCAN™ to pause and control scrolling text

1. When 'Scrolling text' information is displayed in either DAB or FM (RDS), press the dial to pause the scrolling text.



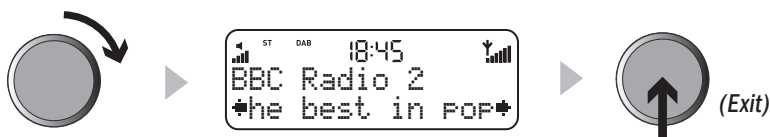

2. Turn the dial left or right to scroll through the current scrolling text message. To exit textSCAN press the dial again.



Intellitext provides on-demand text information such as sports headlines, weather forecasts and news from DAB stations that support the service including BBC Radio Five Live in the UK. The text is updated by the broadcasters and stored in your radio while you listen to stations. Intellitext is listed by station and split into categories, eg, Football, Cricket, Headlines, etc.

To view Intellitext messages

1. Press  Intellitext to enter the Intellitext menu. Push the dial to select 'View' and access a list of stations for which you have Intellitext information (if you see 'No data' you need to tune to a station broadcasting Intellitext for a few minutes before information is received).
2. Push the dial to select a station and rotate and push the dial to browse Intellitext categories for that station, e.g., BBC Radio 5Live > SPORT > FOOTBALL. The selected information will scroll across the screen. Press  Intellitext to go back up to the previous category.



Note: You can use textSCAN (page 5) to pause and control Intellitext messages.

ReVu™ – pause and rewind live radio

ReVu enables you to pause and rewind radio by saving an audio 'buffer' of the current station. You can rewind for approximately 10–15 minutes depending on the broadcast quality of the current station and/or how long you've been tuned to the current station.

To pause and rewind live radio

1. Press  to pause the current station and enter ReVu mode.

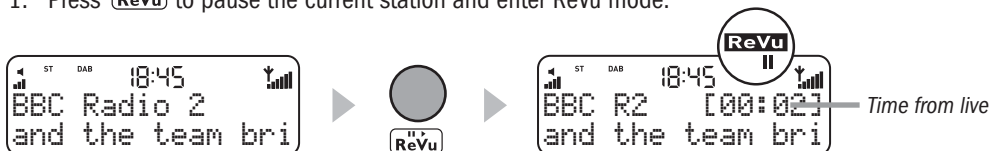

2. When the audio is paused you can do the following:

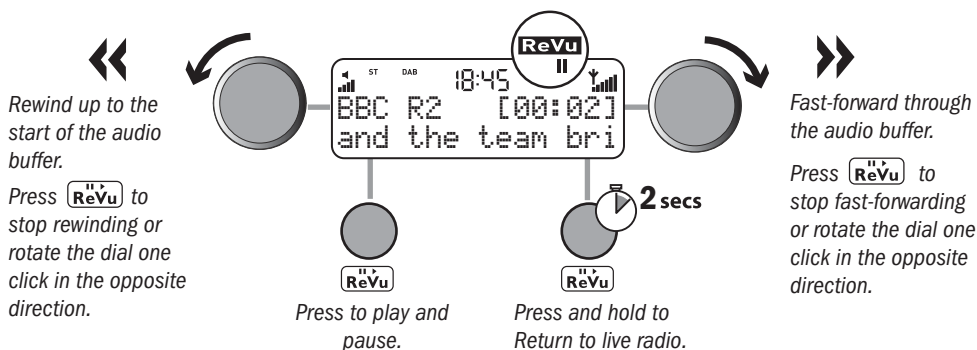

Setting the alarm & timers

Setting the alarm

1. Press the  (Alarm/Timer) button and select *Alarm* to display the alarm status screen.
2. Push the dial to enter the alarm menu. You can scroll through six alarm options on the bottom line of the display, while the top line displays their current setting. To change a setting, push the dial, rotate it to make your selection and then push it to confirm the change.

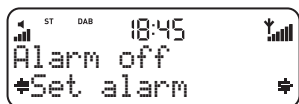

Set alarm

Push dial to choose between 'On' (alarm sounds) or 'Off' (alarm does not sound). The  symbol on the screen indicates that the alarm is on.



Set time

Push dial to set the alarm time. Rotate the dial to set the hour then push to confirm. Repeat to set the minutes.

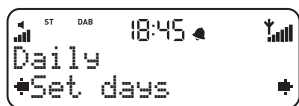

Set days

Push dial to set the days that the alarm sounds. Choose between: *Daily* (every day), *Weekday* (Monday to Friday), *Weekend*, *Saturday*, *Sunday* and *Once only* (alarm does not repeat)



Set alarm mode

Push dial to choose between: *DAB*, *FM* or *Tone* (buzzer).



Select station

If you've set alarm mode as *DAB* or *FM* you can choose 'Select station' and choose a DAB station or an FM Preset and push to confirm. *Last tuned* tunes to the most recent FM station.



Alarm volume

If the alarm mode is set to *DAB* or *FM*, push the dial to change the alarm volume. Rotate the dial left to decrease the alarm volume and right to increase it then push to confirm.

Canceling a sounding alarm

To cancel a tone alarm push the dial or press the **Standby** button.

To cancel a radio alarm press any button.



Note: A sounding alarm will switch off after one hour unless you cancel it.

Note: The alarm will not sound if an iPod, auxiliary device or auxiliary cable is connected to the **LINE IN** socket. Instead, the radio will play any audio from the connected auxiliary device.

Setting the kitchen timer

ONE Elite has a countdown timer which will sound a beeping tone after a set time period – handy for use in the kitchen.

To set a kitchen timer

1. Press  (Alarm/Timer), rotate the dial to display *Kitchen timer* and press dial to select.
2. Rotate the dial to change the hours and push to confirm. Rotate again to change the minutes then push to confirm and start the countdown timer.  is displayed on screen.

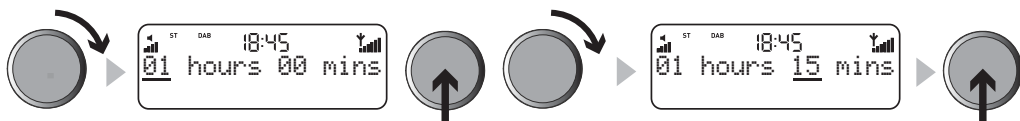

To cancel a kitchen timer

To stop and reset the kitchen timer before it sounds a beeping tone, press and hold down the  (Alarm/Timer) button for three seconds until you see the message 'Timer cleared'.

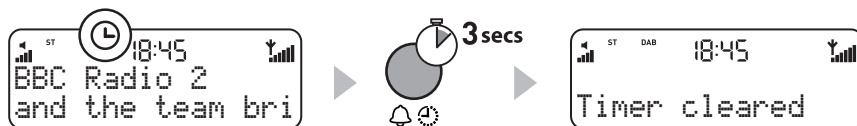

Setting the sleep timer

ONE Elite has a sleep timer that switches your radio into standby (or off if powered by a ChargePAK) after a number of minutes has elapsed. Use this if you want to fall asleep to the radio.

To set a sleep timer

1. Press the  (Alarm/Timer) button, rotate the dial to display *Sleep timer* then push the dial to select.
2. Rotate the dial to increase the duration of the sleep from 15 to 90 minutes in fifteen minute intervals. Press the dial to start the sleep timer.

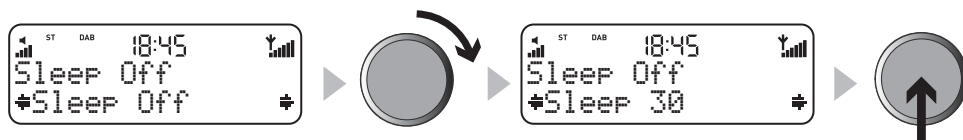

To cancel a sleep timer

Select the *Sleep timer* screen (see above) and set the duration of the Sleep timer to *Sleep Off*. Alternatively, press and hold the  (Alarm/Timer) button for three seconds until you see the message 'Timer cleared'.

Options and settings

Press the **Menu** button to access the options menu, rotate the dial to scroll through and change the options and push the dial to select.

DAB options

Autotune

Scans all DAB Band III and L-Band frequencies for stations, automatically adds any new stations found to the station list and removes inactive stations. To stop an Autotune press **Menu**.

Intellitext options

Press  Intellitext and rotate the dial to access the following options for managing Intellitext messages.

Set timeout Choose to delete old Intellitext messages after 1 week (default) or 1 day.

Clear all Delete all stored Intellitext messages immediately.

FM options

FM tuning mode

Seek When you rotate the dial, the radio tunes to the next station with a good signal.

Manual When you rotate the dial, the radio tunes up or down in steps of 0.05 MHz.

FM stereo mode

Choose from *Stereo* (default) or *Mono*. Mono may improve clarity where stereo signals are weak.

General options

Backlight

Timed The backlight turns on for 7 seconds when any button is pressed (default).

Off The backlight does not switch on.

On The backlight is always on when the radio is on.

Audio

Rotate the dial to adjust the treble or bass and press to confirm.

Treble Adjust the treble between -5 (minimal treble), 0 (neutral) and 5 (high treble).

Bass Adjust the bass between -5 (minimal bass), 0 (neutral) and 5 (maximum bass).

Clock

The clock will automatically set itself and also update for GMT/BST clock changes in the UK.

However, if you cannot receive a DAB signal, the time and date can be manually set by selecting *Set Clock* from the options menu.

Energy saving

ONE Elite is part of the PURE EcoPlus product family, designed and manufactured to minimise power consumption when the unit is switched on and to use less than 1 Watt in standby. One way this low power consumption is enabled is by not collecting and storing Intellitext messages when the unit is in standby. Two options are available:

- On* (default) ONE Elite updates the Intellitext data when you tune to a station that broadcasts Intellitext. Intellitext data is not collected in standby.
- Off* ONE Elite collects Intellitext data in standby from the last station you viewed Intellitext, which increases standby power consumption.

Note: If you fit the optional ChargePAK C6L or 6 x 'C' cell batteries (see below) the unit will switch off when you press the **Standby** button and not enter standby, as long as the unit is not connected to mains power.

Software upgrade

Software updates for your ONE Elite may be made available in the future. If you register your product and include a valid e-mail address you will receive notification of software updates (register at www.pure.com/register or fill in the supplied warranty card). Available software updates are also listed at www.pure.com/support.*

To upgrade your radio

1. Press and hold the **Info** button for three seconds to access the maintenance menu.
2. Select '*Upgrade*' and follow the instructions provided with the upgrade software.

Reset your radio

Resetting your radio removes all presets, clears the station list and resets all options to defaults.

1. Press and hold the **Info** button for three seconds to access the maintenance menu.
2. Rotate the dial to choose '*Factory Reset*' and push the dial to confirm the reset.

Using a ChargePAK™

PURE ChargePAK C6L is a rechargeable battery pack which plugs into the socket in the radio's battery compartment. Whenever your radio is connected to a mains supply the ChargePAK will charge up and the battery icon on screen will animate. When the ChargePAK is fully charged the battery icon will disappear.

To purchase a PURE ChargePAK C6L, contact your nearest PURE dealer, visit the shop on our website at www.pure.com or call the PURE order line on +44 (0)845 148 9001.

Note ONE Elite can only be powered with a ChargePAK C6L or 6 x 'C' cell batteries. Do not use any other ChargePAK model. Carefully follow the separate fitting instructions that are supplied with the ChargePAK C6L.

*Requires a PC (not Mac) with internet access running Windows XP or Vista and a suitable USB cable (not included).

Using the alarm when using ChargePAK C6L or batteries

When a ChargePAK rechargeable battery or 'C' cell batteries are fitted and the unit is not connected to mains power the radio switches off completely when the **Standby** button is pressed. In this case, the message 'Disabling alarm' will be briefly displayed after the **Standby** button is pressed and the alarm will not sound.

Help and specifications

Secondary and inactive stations

(<</>>) Secondary DAB services

Secondary services accompany some stations, providing extra information or alternative content and may only be broadcast at certain times. If a station has secondary services available, the station shows '>>' next to its name in the station list and the secondary service appears next to the station in the list. A secondary service has '<<' before its name in the station list.

(?) Inactive or unavailable DAB stations

Inactive or unavailable stations appear on the station list preceded by '?' and cannot be tuned to. A station may be inactive or unavailable because the station is not broadcasting at the current time (check with the station) or has stopped broadcasting altogether. Alternatively, you may not have a strong enough signal to receive the Multiplex on which the station is broadcast.

Hints and tips

Display says 'No stations available'

Use Autotune (page 9) to search for stations. Try adjusting your aerial or radio position.

Receiving new DAB stations that have started broadcasting

Use Autotune (p 9) to scan for new stations and add any new DAB stations to the station list.

EN

Copyright

Copyright 2008 by Imagination Technologies Limited. All rights reserved. No part of this publication may be copied or distributed, transmitted, transcribed, stored in a retrieval system, or translated into any human or computer language, in any form or by any means, electronic, mechanical, magnetic, manual or otherwise, or disclosed to third parties without the express written permission of Imagination Technologies Limited.

Trademarks

ONE Elite, the ONE Elite logo, Intellitext, textSCAN, ChargePAK, ReVu, PURE, the PURE logo, PURE Digital, the PURE Digital logo, EcoPlus, the EcoPlus logo, Imagination Technologies, and the Imagination Technologies logo are trademarks or registered trademarks of Imagination Technologies Limited. All other product names are trademarks of their respective companies. Version 2 August 2008.

Technical Specifications

General	Stereo digital radio with full Band III, L-Band and FM reception. ETS 300 401 compliant and capable of decoding all DAB transmission modes 1-4 up to and including 192 kbps. Supports FM RDS and RadioText. DAB+ supported as standard in certain countries and available as an upgrade in others. See www.pure.com/support for more details.
Frequency ranges:	DAB Band III 174–240 MHz, L-Band 1452-1490 MHz, FM 87.5–108 MHz.
Speakers:	2 x full-range 3" drive units.
Audio power output:	2.5W RMS per channel; 5W RMS total.
Input connectors:	12V DC power adapter socket (230V adapter supplied), Mini USB connector for software upgrades, 3.5mm Line in for auxiliary devices.
Output connectors:	3.5mm headphone socket
Mains power supply:	230V AC to 12V (0.8A) DC external power adapter.
Power consumption:	In standby 0.67W (industry average 2.64W); in operation 2.46W on average (industry average 5.49W).
Battery power supply:	Six C (R14) batteries or ChargePAK C6L (not supplied).
Approvals:	CE marked. Compliant with the EMC and Low Voltage Directives (89/336/EEC and 73/23/EEC).
Dimensions (mm):	256 wide x 155 high x 88 deep (excluding controls).
Aerial:	Integral telescopic aerial.

Go to www.pure.com/support for a list of frequently asked questions relating to this product.

Need help?

We want you to get the most out of your ONE Elite and enjoy all that digital radio has to offer. If you have any questions about the product after reading this manual, please visit our support website or contact a member of our support team by phone or e-mail.

Returns & Repairs

If this product develops a fault within the warranty period we'll organise a repair or replace it if necessary. Read the 'Warranty information' inside for information about the warranty period, terms and conditions.



+44 (0)845 148 9001

(9am–5:30pm, Mon–Fri)



support@pure.com

www.pure.com/support

Disposal of Waste Electrical & Electronic Equipment



This symbol on the product or on its packaging indicates that this product should not be treated as household waste. Instead it should be handed over to a suitable collection point for the recycling of electrical and electronic equipment. By ensuring this product is disposed of correctly, you will help prevent potential negative consequences for the environment and human health, which could otherwise be caused by inappropriate waste handling of this product. The recycling of materials will help to conserve natural resources. For more detailed information about recycling of this product, please contact your local council office, your household waste disposal service or the shop where you purchased the product.

www.pure.com

PURE Digital +44 (0)845 148 9001 sales and support
Imagination Technologies Ltd. +44 (0)845 148 9002 trade sales and support
Home Park Estate +44 (0)845 148 9003 fax
Kings Langley support@pure.com
Herts, WD4 8LZ sales@pure.com
United Kingdom

PURE Digital +49 (0)6158 878872 sales
Karl-Marx Strasse 6 +49 (0)6158 878874 fax
64589 Stockstadt/Rhein sales_gmbh@pure.com
Germany

PURE Digital - Vertrieb über: +41 (0)62 285 95 95 sales
TELANOR AG +41 (0)62 285 95 85 fax
Unterhaltungselektronik info@telanor.ch
Bachstrasse 42 www.telanor.ch
4654 Lostorf
Schweiz/Switzerland

PURE Australasia Pty Ltd +61 (0)3 9722 2422 sales and support
PO Box 5049 +61 (0)3 9722 2104 fax
Wonga Park. support_aus@pure.com
Victoria 3115 sales_aus@pure.com
Australia



EcoPlus



ONE Elite is a member of the PURE EcoPlus™ product family. All EcoPlus products are designed and manufactured to minimise their environmental impact.

- Documentation is printed on 100% recycled paper using soya-based ink.
- The retail carton protecting your product is printed on at least 70% recycled card finished using a water-based varnish and sized for maximum transport efficiency.

For more information please visit www.pure.com/ecoplus

